

Installation Instructions

Original Instructions



Allen-Bradley

by ROCKWELL AUTOMATION

POINT I/O DeviceNet Adapter

Catalog Numbers 1734-ADN, 1734-ADNK, 1734-ADNX

Topic	Page
Summary of Changes	1
Before You Begin	5
Install the Adapter	5
Install a Replacement Adapter in an Existing System	6
Wire the Adapter	7
Interpret Status Indicators	8
Specifications	9
Additional Resources	11

Summary of Changes

This publication contains the following new or updated information. This list includes substantive updates only and is not intended to reflect all changes.

Topic	Page
Updated module dimensions	10
Updated Certifications	11
Updated Additional Resources	11
Updated back cover	back cover



ATTENTION: Read this document and the documents listed in the Additional Resources section about installation, configuration and operation of this equipment before you install, configure, operate or maintain this product. Users are required to familiarize themselves with installation and wiring instructions in addition to requirements of all applicable codes, laws, and standards.

Activities including installation, adjustments, putting into service, use, assembly, disassembly, and maintenance are required to be carried out by suitably trained personnel in accordance with applicable code of practice. If this equipment is used in a manner not specified by the manufacturer, the protection provided by the equipment may be impaired.

注意：在安装、配置、操作和维护本产品前，请阅读本文档以及“其他资源”部分列出的有关设备安装、配置和操作的相应文档。除了所有适用规范、法律和标准的相关要求之外，用户还必须熟悉安装和接线说明。

安装、调整、投运、使用、组装、拆卸和维护等各项操作必须由经过适当训练的专业人员按照适用的操作规范实施。

如果未按照制造商指定的方式使用该设备，则可能会损害设备提供的保护。

ATENCIÓN: Antes de instalar, configurar, poner en funcionamiento o realizar el mantenimiento de este producto, lea este documento y los documentos listados en la sección Recursos adicionales acerca de la instalación, configuración y operación de este equipo. Los usuarios deben familiarizarse con las instrucciones de instalación y cableado y con los requisitos de todos los códigos, leyes y estándares vigentes.

El personal debidamente capacitado debe realizar las actividades relacionadas a la instalación, ajustes, puesta en servicio, uso, ensamblaje, desensamblaje y mantenimiento de conformidad con el código de práctica aplicable. Si este equipo se usa de una manera no especificada por el fabricante, la protección provista por el equipo puede resultar afectada.

ATENÇÃO: Leia este e os demais documentos sobre instalação, configuração e operação do equipamento que estão na seção Recursos adicionais antes de instalar, configurar, operar ou manter este produto. Os usuários devem se familiarizar com as instruções de instalação e fiação além das especificações para todos os códigos, leis e normas aplicáveis.

É necessário que as atividades, incluindo instalação, ajustes, colocação em serviço, utilização, montagem, desmontagem e manutenção sejam realizadas por pessoal qualificado e especializado, de acordo com o código de prática aplicável.

Caso este equipamento seja utilizado de maneira não estabelecida pelo fabricante, a proteção fornecida pelo equipamento pode ficar prejudicada.

ВНИМАНИЕ: Перед тем как устанавливать, настраивать, эксплуатировать или обслуживать данное оборудование, прочитайте этот документ и документы, перечисленные в разделе «Дополнительные ресурсы». В этих документах изложены сведения об установке, настройке и эксплуатации данного оборудования. Пользователи обязаны ознакомиться с инструкциями по установке и прокладке соединений, а также с требованиями всех применимых норм, законов и стандартов.

Все действия, включая установку, наладку, ввод в эксплуатацию, использование, сборку, разборку и техническое обслуживание, должны выполняться обученным персоналом в соответствии с применимыми нормами и правилами.

Если оборудование используется не предусмотренным производителем образом, защита оборудования может быть нарушена.

注意：本製品を設置、構成、稼働または保守する前に、本書および本機器の設置、設定、操作についての参考資料の該当箇所に記載されている文書に目を通してください。ユーザは、すべての該当する条例、法律、規格の要件に加えて、設置および配線の手順に習熟している必要があります。

設置調整、運転の開始、使用、組立て、解体、保守を含む諸作業は、該当する実施規則に従って訓練を受けた適切な作業員が実行する必要があります。

本機器が製造メーカーにより指定されていない方法で使用されている場合、機器により提供されている保護が損なわれる恐れがあります。

ACHTUNG: Lesen Sie dieses Dokument und die im Abschnitt „Weitere Informationen“ aufgeführten Dokumente, die Informationen zu Installation, Konfiguration und Bedienung dieses Produkts enthalten, bevor Sie dieses Produkt installieren, konfigurieren, bedienen oder warten. Anwender müssen sich neben den Bestimmungen aller anwendbaren Vorschriften, Gesetze und Normen zusätzlich mit den Installations- und Verdrahtungsanweisungen vertraut machen.

Arbeiten im Rahmen der Installation, Anpassung, Inbetriebnahme, Verwendung, Montage, Demontage oder Instandhaltung dürfen nur durch ausreichend geschulte Mitarbeiter und in Übereinstimmung mit den anwendbaren Ausführungsvorschriften vorgenommen werden.

Wenn das Gerät in einer Weise verwendet wird, die vom Hersteller nicht vorgesehen ist, kann die Schutzfunktion beeinträchtigt sein.

ATTENTION: Lisez ce document et les documents listés dans la section Ressources complémentaires relatifs à l'installation, la configuration et le fonctionnement de cet équipement avant d'installer, configurer, utiliser ou entretenir ce produit. Les utilisateurs doivent se familiariser avec les instructions d'installation et de câblage en plus des exigences relatives aux codes, lois et normes en vigueur.

Les activités relatives à l'installation, le réglage, la mise en service, l'utilisation, l'assemblage, le démontage et l'entretien doivent être réalisées par des personnes formées selon le code de pratique en vigueur.

Si cet équipement est utilisé d'une façon qui n'a pas été définie par le fabricant, la protection fournie par l'équipement peut être compromise.

주의：본 제품 설치, 설정, 작동 또는 유지 보수가 하기 전에 본 문서를 포함하여 설치, 설정 및 작동에 관한 참고 자료 섹션의 문서들을 반드시 읽고 숙지하십시오. 사용자는 모든 관련 규정, 법규 및 표준에서 요구하는 사항에 대해 반드시 설치 및 배선 지침을 숙지해야 합니다.

설치, 조정, 가동, 사용, 조립, 분해, 유지보수 등 모든 작업은 관련 규정에 따라 적절한 교육을 받은 사용자를 통해서만 수행해야 합니다.

본 장비를 제조사가 명시하지 않은 방법으로 사용하면 장비의 보호 기능이 손상될 수 있습니다.

ATTENZIONE: Prima di installare, configurare ed utilizzare il prodotto, o effettuare interventi di manutenzione su di esso, leggere il presente documento ed i documenti elencati nella sezione "Altre risorse", riguardanti l'installazione, la configurazione ed il funzionamento dell'apparecchiatura. Gli utenti devono leggere e comprendere le istruzioni di installazione e cablaggio, oltre ai requisiti previsti dalle leggi, codici e standard applicabili.

Le attività come installazione, regolazioni, utilizzo, assemblaggio, disassemblaggio e manutenzione devono essere svolte da personale adeguatamente addestrato, nel rispetto delle procedure previste.

Qualora l'apparecchio venga utilizzato con modalità diverse da quanto previsto dal produttore, la sua funzione di protezione potrebbe venire compromessa.

DİKKAT: Bu ürünün kurulumu, yapılandırılması, işletilmesi veya bakımı öncesinde bu dokümanı ve bu ekipmanın kurulumu, yapılandırılması ve işletimi ile ilgili ilave Kaynaklar bölümünde yer listelenmiş dokümanları okuyun. Kullanıcılar yürürlükteki tüm yönetmelikler, yasalar ve standartların gereksinimlerine ek olarak kurulum ve kablolama talimatlarını da öğrenmek zorundadır. Kurulum, ayarlama, bakım veya hizmete alma, kullannya, parçaları birleştirme, hizmetleri sadece uygun eğitimleri almış kişiler tarafından yürürlükteki uygulamaya yönetmeliklerine uygun şekilde yapılabilir.

Yö ekipman üretici tarafından belirlenmiş amacın dışında kullanılırsa, ekipman tarafından sağlanan koruma bozulabilir.

注意事項：在安装、設定、操作或維護本产品前，請先閱讀此文件以及列於「其他資源」章節中有關安裝、設定與操作此設備的文件。使用者必須熟悉安裝和配線指示，並符合所有法規、法律和標準要求。

包括安裝、調整、交付使用、使用、組裝、拆卸和維護等動作都必須交由已經過適當訓練的人員進行，以符合適用的實作法規。

如果將設備用於非製造商指定的用途時，可能會造成設備所提供的保護功能受損。

POZOR: Než začnete instalovat, konfigurovat či provozovat tento výrobek nebo provádět jeho údržbu, přečtěte si tento dokument a dokumenty uvedené v části Dodatečné zdroje ohledně instalace, konfigurace a provozu tohoto zařízení. Uživatelé se musejí vedle požadavků všech relevantních vyhlášek, zákonů a norem nutně seznámit také s pokyny pro instalaci a elektrické zapojení.

Činnosti zahrnující instalaci, nastavení, uvedení do provozu, užívání, montáž, demontáž a údržbu musí vykonávat vhodně proškolený personál v souladu s příslušnými prováděcími předpisy. Pokud se toto zařízení používá způsobem neodpovídajícím specifikaci výrobce, může být narušena ochrana, kterou toto zařízení poskytuje.

UWAGA: Przed instalacją, konfiguracją, użytkowaniem lub konserwacją tego produktu należy przeczytać niniejszy dokument oraz wszystkie dokumenty wymienione w sekcji Dodatkowe źródła omawiające instalację, konfigurację i procedury użytkowania tego urządzenia. Użytkownicy mają obowiązek zapoznać się z instrukcjami dotyczącymi instalacji oraz oprowadowania, jak również z obowiązującymi kodeksami, prawem i normami.

Działania obejmujące instalację, regulację, przekazanie do użytkowania, użytkowanie, montaż, demontaż oraz konserwację muszą być wykonywane przez odpowiednio przeszkolony personel zgodnie z obowiązującym kodeksem postępowania.

Jeśli urządzenie jest użytkowane w sposób inny niż określony przez producenta, zabezpieczenie zapewniane przez urządzenie może zostać ograniczone.

OBS! Läs detta dokument samt dokumentet, som står listat i avsnittet Övriga resurser, om installation, konfigurering och drift av denna utrustning innan du installerar, konfigurerar eller börjar använda eller utföra underhållsarbete på produkten. Användare måste bekanta sig med instruktioner för installation och kabeldragning, förutom krav enligt gällande koder, lagar och standarder.

Åtgärder som installation, justering, service, användning, montering, demontering och underhållsarbete måste utföras av personal med lämplig utbildning enligt lämpligt bruk.

Om denna utrustning används på ett sätt som inte anges av tillverkaren kan det hända att utrustningens skyddsanordningar försätts ur funktion.

LET OP: Lees dit document en de documenten die genoemd worden in de paragraaf Aanvullende informatie over de installatie, configuratie en bediening van deze apparatuur voordat u dit product installeert, configureert, bedient of onderhoudt. Gebruikers moeten zich vertrouwd maken met de installatie en de bedringsinstructies, naast de vereisten van alle toepasselijke regels, wetten en normen.

Activiteiten zoals het installeren, afstellen, in gebruik stellen, gebruiken, monteren, demonteren en het uitvoeren van onderhoud mogen uitsluitend worden uitgevoerd door hiervoor opgeleide personeel en in overeenstemming met de geldende praktijkregels.

Indien de apparatuur wordt gebruikt op een wijze die niet is gespecificeerd door de fabrikant, dan bestaat het gevaar dat de beveiliging van de apparatuur niet goed werkt.

Environment and Enclosure



ATTENTION: This equipment is intended for use in a Pollution Degree 2 industrial environment, in overvoltage Category II applications (as defined in EN/IEC 60664-1), at altitudes up to 2000 m (6562 ft) without derating. This equipment is not intended for use in residential environments and may not provide adequate protection to radio communication services in such environments.

This equipment is supplied as open-type equipment for indoor use. It must be mounted within an enclosure that is suitably designed for those specific environmental conditions that will be present and appropriately designed to prevent personal injury resulting from accessibility to live parts. The enclosure must have suitable flame-retardant properties to prevent or minimize the spread of flame, complying with a flame spread rating of 5VA or be approved for the application if nonmetallic. The interior of the enclosure must be accessible only by the use of a tool. Subsequent sections of this publication may contain more information regarding specific enclosure type ratings that are required to comply with certain product safety certifications.

In addition to this publication, see the following:

- Industrial Automation Wiring and Grounding Guidelines, publication [1770-4.1](#), for additional installation requirements.
- NEMA Standard 250 and EN/IEC 60529, as applicable, for explanations of the degrees of protection provided by enclosures.



ATTENTION: Read this document and the documents listed in the Additional Resources section about installation, configuration, and operation of this equipment before you install, configure, operate, or maintain this product. Users are required to familiarize themselves with installation and wiring instructions in addition to requirements of all applicable codes, laws, and standards.

Installation, adjustments, putting into service, use, assembly, disassembly, and maintenance are required to be carried out by suitably trained personnel in accordance with applicable code of practice. In case of malfunction or damage, no attempts at repair should be made. The module should be returned to the manufacturer for repair. Do not dismantle the module.

North American Hazardous Location Approval

The Following Information Applies When Operating This Equipment In Hazardous Locations.	Informations sur l'utilisation de cet équipement en environnements dangereux.
<p>Products marked "CL I, DIV 2, GP A, B, C, D" are suitable for use in Class I Division 2 Groups A, B, C, D, Hazardous Locations and nonhazardous locations only. Each product is supplied with markings on the rating nameplate indicating the hazardous location temperature code. When combining products within a system, the most adverse temperature code (lowest "T" number) may be used to help determine the overall temperature code of the system. Combinations of equipment in your system are subject to investigation by the local Authority Having Jurisdiction at the time of installation.</p>	<p>Les produits marqués "CL I, DIV 2, GP A, B, C, D" ne conviennent qu'à une utilisation en environnements de Classe I Division 2 Groupes A, B, C, D dangereux et non dangereux. Chaque produit est livré avec des marquages sur sa plaque d'identification qui indiquent le code de température pour les environnements dangereux. Lorsque plusieurs produits sont combinés dans un système, le code de température le plus défavorable (code de température le plus faible) peut être utilisé pour déterminer le code de température global du système. Les combinaisons d'équipements dans le système sont sujettes à inspection par les autorités locales qualifiées au moment de l'installation.</p>
<div style="display: flex; align-items: center;"> <div> <p>WARNING: Explosion Hazard -</p> <ul style="list-style-type: none"> • Do not disconnect equipment unless power has been removed or the area is known to be nonhazardous. • Do not disconnect connections to this equipment unless power has been removed or the area is known to be nonhazardous. Secure any external connections that mate to this equipment by using screws, sliding latches, threaded connectors, or other means provided with this product. • Substitution of components may impair suitability for Class I Division 2. </div> </div>	<div style="display: flex; align-items: center;"> <div> <p>AVERTISSEMENT: Risque d'Explosion -</p> <ul style="list-style-type: none"> • Couper le courant ou s'assurer que l'environnement est classé non dangereux avant de débrancher l'équipement. • Couper le courant ou s'assurer que l'environnement est classé non dangereux avant de débrancher les connecteurs. Fixer tous les connecteurs externes reliés à cet équipement à l'aide de vis, loquets coulissants, connecteurs filetés ou autres moyens fournis avec ce produit. • La substitution de composants peut rendre cet équipement inadapté à une utilisation en environnement de Classe I Division 2. </div> </div>

UK and European Hazardous Location Approval

The following applies to products marked II 3 G:

- Are intended for use in potentially explosive atmospheres as defined by UKEX regulation 2016 No. 1107 and European Union Directive 2014/34/EU and has been found to comply with the Essential Health and Safety Requirements relating to the design and construction of Category 3 equipment intended for use in Zone 2 potentially explosive atmospheres, given in Schedule 1 of UKEX and Annex II of this Directive.
- Compliance with the Essential Health and Safety Requirements has been assured by compliance with EN IEC 60079-7, and EN IEC 60079-0.
- Are Equipment Group II, Equipment Category 3, and comply with the Essential Health and Safety Requirements relating to the design and construction of such equipment given in Annex II to EU Directive 2014/34/EU. See the UKEx and EU Declaration of Conformity at rok.auto/certifications for details.
- The type of protection is Ex ec IIC T4 Gc according to EN IEC 60079-0:2018, EXPLOSIVE ATMOSPHERES - PART 0: EQUIPMENT - GENERAL REQUIREMENTS, Issue Date 07/2018, and CENELEC EN IEC 60079-7:2015+A1:2018, Explosive atmospheres. Equipment protection by increased safety "e".
- Comply with Standard EN IEC 60079-0:2018, EXPLOSIVE ATMOSPHERES - PART 0: EQUIPMENT - GENERAL REQUIREMENTS, Issue Date 07/2018, and CENELEC EN IEC 60079-7:2015+A1:2018 Explosive atmospheres. Equipment protection by increased safety "e", reference certificate number DEMKO 04 ATEX 0330347X and UL22UKEX2478X.
- Are intended for use in areas in which explosive atmospheres caused by gases, vapors, mists, or air are unlikely to occur, or are likely to occur only infrequently and for short periods. Such locations correspond to Zone 2 classification according to UKEX regulation 2016 No. 1107 and ATEX directive 2014/34/EU.
- May have catalog numbers followed by a "K" to indicate a conformal coating option.

IEC Hazardous Location Approval

The following applies to products IECEx certification:

- Are intended for use in areas in which explosive atmospheres caused by gases, vapors, mists, or air are unlikely to occur, or are likely to occur only infrequently and for short periods. Such locations correspond to Zone 2 classification to IEC 60079-0.
 - The type of protection is Ex eC IIC T4 Gc according to IEC 60079-0 and IEC 60079-7.
 - Comply with Standards IEC 60079-0, Explosive atmospheres - Part 0: Equipment - General requirements, Edition 7, Revision Date 2017 and IEC 60079-7, 5.1 Edition revision date 2017, Explosive atmospheres - Part 7: Equipment protection by increased safety "e", reference IECEx certificate number IECEx UL 20.0072X.
 - May have catalog numbers followed by a "K" to indicate a conformal coating option.
-

Special Conditions for Safe Use**WARNING:**

- This equipment is not resistant to sunlight or other sources of UV radiation.
 - This equipment shall be mounted in an UKEX/ATEX/IECEx Zone 2 certified enclosure with a minimum ingress protection rating of at least IP54 (in accordance with EN/IEC 60079-0) and used in an environment of not more than Pollution Degree 2 (as defined in EN/IEC 60664-1) when applied in Zone 2 environments. The enclosure must be accessible only by the use of a tool.
 - This equipment shall be used within its specified ratings defined by Rockwell Automation.
 - Transient protection shall be provided that is set at a level not exceeding 140% of the peak rated voltage at the supply terminals to the equipment.
 - Earthing is accomplished through mounting of modules on rail.
 - The instructions in the user manual shall be observed.
 - This equipment must be used only with UKEX/ATEX/IECEx certified Rockwell Automation backplanes.
 - Secure any external connections that mate to this equipment by using screws, sliding latches, threaded connectors, or other means provided with this product.
 - Do not disconnect equipment unless power has been removed or the area is known to be nonhazardous. Earthing is accomplished through mounting of modules on rail.
 - Devices shall be used in an environment of not more than Pollution Degree 2.
-

Prevent Electrostatic Discharge

ATTENTION: This equipment is sensitive to electrostatic discharge, which can cause internal damage and affect normal operation. Follow these guidelines when you handle this equipment:

- Touch a grounded object to discharge potential static.
 - Wear an approved grounding wriststrap.
 - Do not touch connectors or pins on component boards.
 - Do not touch circuit components inside the equipment.
 - Use a static-safe workstation, if available.
 - Store the equipment in appropriate static-safe packaging when not in use.
-

**ATTENTION:**

- If this equipment is used in a manner not specified by the manufacturer, the protection provided by the equipment may be impaired.
 - Read this document and the documents listed in the Additional Resources section about installation, configuration, and operation of this equipment before you install, configure, operate, or maintain this product. Users are required to familiarize themselves with installation and wiring instructions in addition to requirements of all applicable codes, laws, and standards.
 - Installation, adjustments, putting into service, use, assembly, disassembly, and maintenance are required to be carried out by suitably trained personnel in accordance with applicable code of practice.
In case of malfunction or damage, no attempts at repair should be made. The module should be returned to the manufacturer for repair. Do not dismantle the module.
 - This equipment is certified for use only within the surrounding air temperature range of -20...+55 °C (-4...+131 °F). The equipment must not be used outside of this range.
 - Use only a soft dry anti-static cloth to wipe down equipment. Do not use any cleaning agents.
-

**WARNING:**

- Secure any external connections that mate to this equipment by using screws, sliding latches, threaded connectors, or other means provided with this product.
 - Do not disconnect equipment unless power has been removed or the area is known to be nonhazardous.
 - The secondary of a current transformer shall not be open-circuited when applied in Class I, Zone 2 environments.
-

IMPORTANT

In this manual, we use 1734-ADN(X) to refer to both of the following adapters:

- 1734-ADN, 1734-ADNK POINT I/O™ DeviceNet® adapter
- 1734-ADNX POINT I/O DeviceNet adapter with Subnet expansion

We use 1734-ADN, 1734-ADNK to refer only to the 1734-ADN, 1734-ADNK adapter and 1734-ADNX to refer only to the 1734-ADNX adapter. We also refer to the 1734-ADN(X) POINT I/O DeviceNet adapter as the adapter.

Before You Begin

The 1734-ADN(X) POINT I/O DeviceNet adapter is a communication adapter for POINT I/O modules.

The adapter provides an interface for controlling and communicating with POINT I/O modules on a DeviceNet network.

For more detailed information about the use of the adapter, see the POINT I/O DeviceNet Adapter User Manual, publication [1734-UM002](#).

Install the Adapter

To install the adapter on the DIN rail before installing other base units, proceed as follows:



ATTENTION: This product is grounded through the DIN rail to chassis ground. Use zinc-plated chromate-passivated steel DIN rail to assure proper grounding. The use of other DIN rail materials (for example, aluminum or plastic) that can corrode, oxidize, or are poor conductors, can result in improper or intermittent grounding. Secure DIN rail to mounting surface approximately every 200 mm (7.8 in.) and use end-anchors appropriately. Be sure to ground the DIN rail properly. See the Industrial Automation Wiring and Grounding Guidelines, publication [1770-4.1](#), for more information.

1. Position the adapter vertically in front of the DIN rail.
2. Press firmly to install the adapter on the DIN rail.
The locking mechanism locks the adapter to the DIN rail.

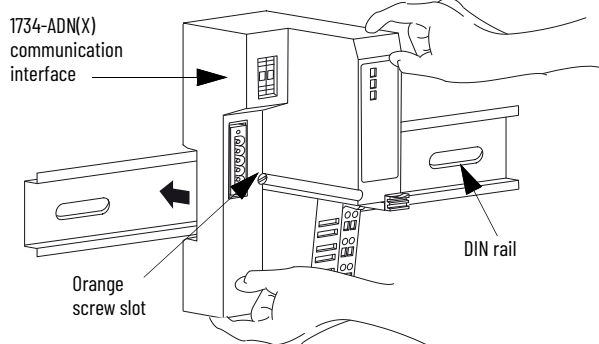

3. Insert the DeviceNet network plug and tighten the holding screws.

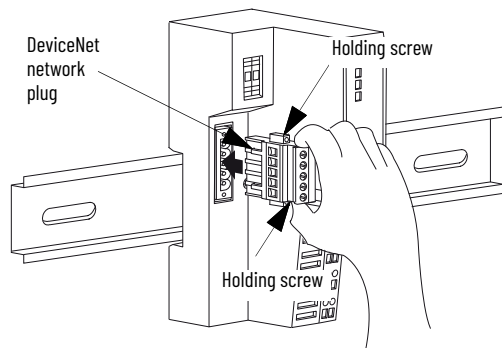

WARNING: If you connect or disconnect the communication cable with power applied to this module or any device on the network, an electric arc can occur. This could cause an explosion in hazardous location installations.

4. Set the node address by pressing the + and - buttons on the 2-position thumbwheel switch.

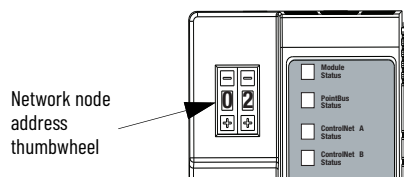

Valid physical settings range from 00...63.

You can also set the node address to some value between 64...99. In this case, you can change the adapter node address via the RSNetWorx™ for DeviceNet software.

If you use a value between 64...99, at power-up you use the node address that is stored in the adapter's nonvolatile memory.

5. Slide the safety end cap to remove it.
This exposes the backplane and power interconnections.



ATTENTION: Do not discard the end cap. Use this end cap to cover the exposed interconnections on the last mounting base on the DIN rail. Failure to do so could result in equipment damage or injury from electric shock.

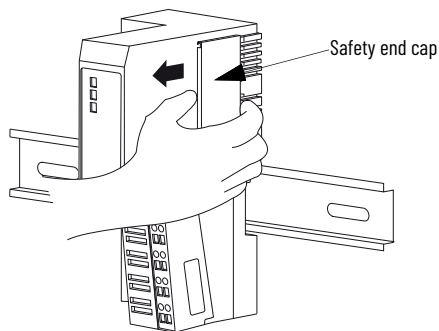

Install a Replacement Adapter in an Existing System



ATTENTION: When you insert or remove the module while backplane power is on, an electric arc can occur. This could cause an explosion in hazardous location installations.

Be sure that power is removed or the area is nonhazardous before proceeding. Repeated electrical arcing causes excessive wear to contacts on both the module and its mating connector. Worn contacts may create electrical resistance that can affect module operation.



ATTENTION: When you connect or disconnect the Removable Terminal Block (RTB) with field-side power applied, an electric arc can occur. This could cause an explosion in hazardous location installations.

Be sure that power is removed or the area is nonhazardous before proceeding.

Your existing control application may be using another DeviceNet adapter (for example, 1734-PDN) that you want to replace with a 1734-ADN(X) DeviceNet adapter. Remove the existing adapter from the DIN rail as follows:

1. Remove power to the adapter and all I/O modules in your existing system.
2. Remove the wiring assembly and DeviceNet cable from your existing adapter.
3. Remove the adjacent I/O module.

For information about how to remove POINT I/O modules from the DIN rail, see the associated publications for those modules.

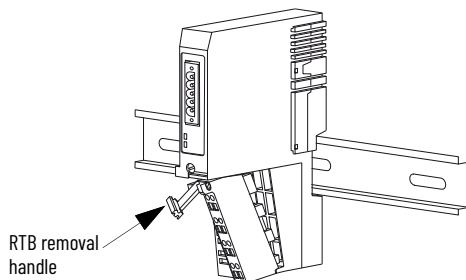

4. Use a small-bladed screwdriver to rotate the DIN rail locking screw to a vertical position and release the locking mechanism.

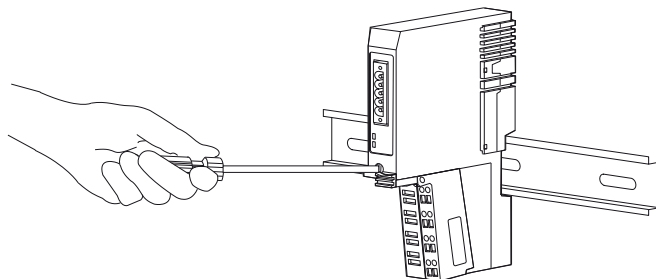

5. Pull the adapter off the DIN rail to remove it from the existing system.
6. Insert the new adapter into slot 0 using the steps described in [Install the Adapter on page 5](#).
7. Reattach I/O modules to the new adapter.

Wire the Adapter



ATTENTION: If you connect or disconnect the communications cable with power applied to this module or any device on the network, an electric arc can occur. This could cause an explosion in hazardous location installations.



ATTENTION: If you connect or disconnect wiring while the field-side power is on, an electric arc can occur. This could cause an explosion in hazardous location installations. Be sure that power is removed or the area is nonhazardous before proceeding.

Adapter Connectors

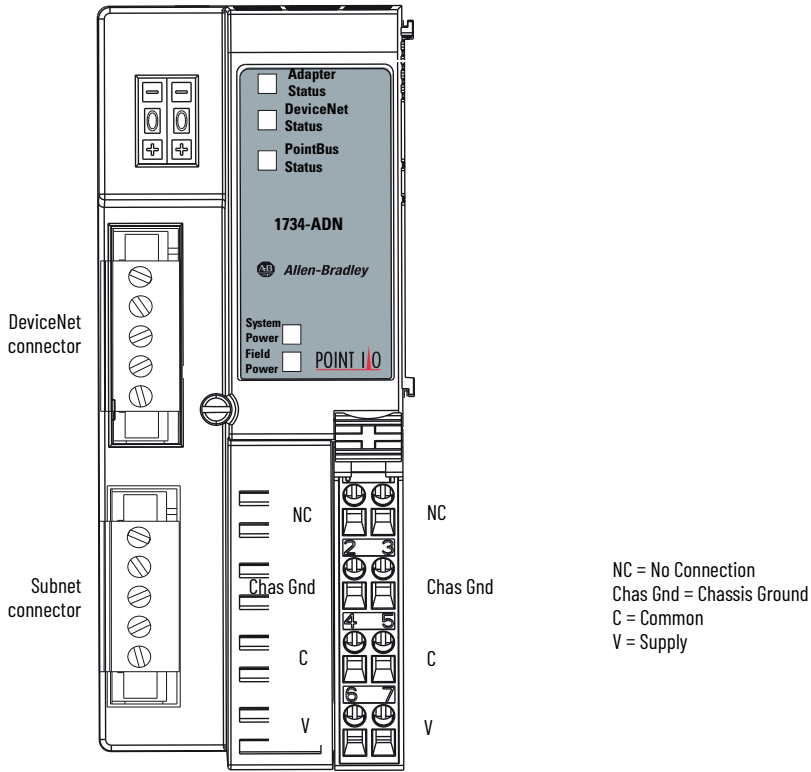

Adapter Wiring

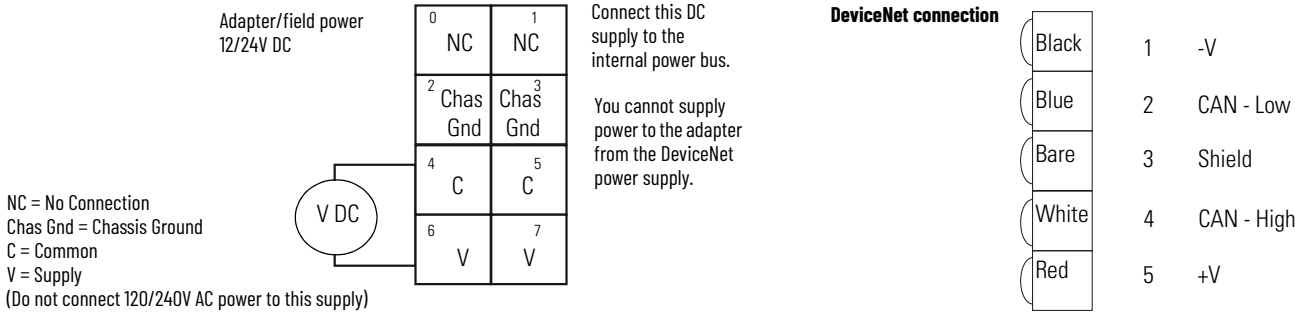

Terminal		Notes
0	No connection	
1	No connection	Reserved
2	Chassis ground	
3	Chassis ground	
4	Common	
5	Common	
6	Voltage input	Apply 12/24V DC
7	Voltage input	Connects to the internal power bus.

Interpret Status Indicators

Use the status indicators to troubleshoot your adapter.

Status Indicators

1734-ADN, 1734-ADNK Adapters

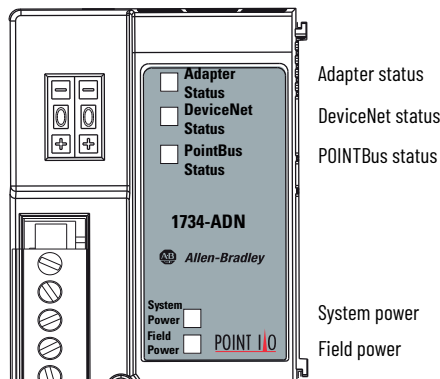

1734-ADNX Adapters

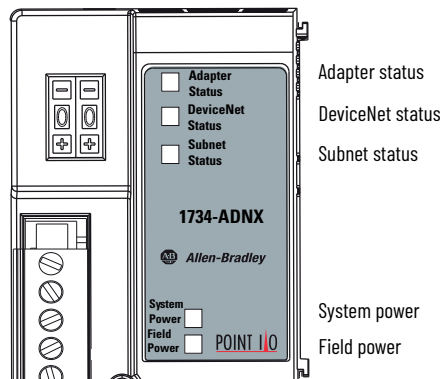

Interpret Status Indicators

Indicator	Indication	Probable Cause	Take This Action
System power	Off	<ul style="list-style-type: none"> Not active The field power is OFF. DC-DC converter problem 	<ul style="list-style-type: none"> Check the adapter configuration. Turn the field power ON. Contact Customer Support.
	Steady green	<ul style="list-style-type: none"> The system power is ON. DC-DC converter is active (5V). 	None
Field power	Off	<ul style="list-style-type: none"> Not active The field power is OFF. 	<ul style="list-style-type: none"> Check adapter configuration. Turn the field power ON.
	Steady green	The power is ON with 24V present.	None
Adapter status	Off	No power is applied to device.	Power the adapter.
	Steady green	The device is operating normally.	None
	Flashing green	The device must be commissioned because configuration is missing, incomplete, or incorrect	Check the configuration and recommission the adapter.
	Flashing red	A recoverable fault is present.	Verify that the adapter does not need a FLASH update.
	Steady red	An unrecoverable fault occurred that may require device replacement.	Replace the adapter.
DeviceNet status	Flashing red/green	The device is in self-test.	Wait for the self-test to finish.
	Off	The device is not online. <ul style="list-style-type: none"> The device is autobauding The device has not completed dup_MAC_id test. The device is not powered. 	Check the adapter status indicator to determine if you need more time to complete the dup_MAC_id test or if you need to power the adapter.
	Flashing green	The device is online but has no connections in the established state.	None
	Steady green	The device is online and has connections in the established state.	None
	Flashing red	One or more I/O connections are in a timed-out state.	Determine the cause of the timeout. You may need to increase the expected packet rate.
Subnet and POINTBus™ status	Steady red	Critical link failure - Communication device failed. The device has detected an error that prevents it from communicating on the network.	Verify that the device is using the correct MAC ID and baudrate.
	Off	The device is not online. <ul style="list-style-type: none"> The device has not completed Dup_MAC_ID test. The device is not powered. Check module status indicator. 	Check adapter status indicator to determine if you need more time to complete the dup_MAC_id test or if you need to power the adapter.
	Flashing green	The device is online but has no connections in the established state.	None
	Steady green	The device is online and has connections in the established state.	None
	Flashing red	No scanlist is available. I/O module is missing. Max backplane MAC ID is not set right (1734-ADNX).	Verify that all I/O modules are connected and using the correct MAC IDs. Check "Cycling Node Status" parameter in RSNetWorx for DeviceNet. For 1734-ADNX, terminate the 1734-ADNX Subnet and correctly set the Max Backplane MAC ID. ⁽¹⁾
Steady red			

(1) Max Backplane MAC ID is an attribute for 1734-ADNX only. This value represents the highest node address of a module residing on the backplane. The value must be greater than or equal to the right-most backplane Subnet module, but less than that of any non-backplane Subnet module.

Specifications

Communication Interface Specifications

Attribute	Value																																																															
DeviceNet communication rate	125K bit/s (500 m max) 250K bit/s (250 m max) 500K bit/s (100 m max)																																																															
DeviceNet cable	Allen-Bradley part number 1485C-P1-Cxxx																																																															
Module location	Starter module - Left side of POINT I/O system																																																															
Number of powered modules, max	63																																																															
Number of integrated I/O channels	0																																																															
Number of I/O points, max	504																																																															
DeviceNet nodes with maximum I/O, total	1																																																															
Node address	1																																																															
I/O module capacity	63																																																															
DeviceNet current	30 mA																																																															
POINTBus current	1000 mA @5V DC \pm 5% (4.75...5.25V)																																																															
Expansion I/O capacity	Up to 13 modules (13 times 75 mA = 0.975 A, just under the limit of 1.0 A), based on POINTBus current requirements. The actual number of modules can vary. Add up the current requirements of the modules that you want to use to make sure that they do not exceed the amperage limit of the adapter. Total expansion is up to 63 modules - 13 modules maximum with the adapter. Add 1734-EP24DC modules for an additional 17 modules (or less based on current requirements), up to 63 modules max																																																															
	<table border="1"> <thead> <tr> <th>Catalog Number</th> <th>POINTBus Current Requirements</th> </tr> </thead> <tbody> <tr><td>1734-IB2</td><td>75 mA</td></tr> <tr><td>1734-IB4</td><td>75 mA</td></tr> <tr><td>1734-IB8</td><td>75 mA</td></tr> <tr><td>1734-IV2</td><td>75 mA</td></tr> <tr><td>1734-IV4</td><td>75 mA</td></tr> <tr><td>1734-OB2</td><td>75 mA</td></tr> <tr><td>1734-OB4</td><td>75 mA</td></tr> <tr><td>1734-OB8</td><td>75 mA</td></tr> <tr><td>1734-OB2E</td><td>75 mA</td></tr> <tr><td>1734-OB2EP</td><td>75 mA</td></tr> <tr><td>1734-OB4E</td><td>75 mA</td></tr> <tr><td>1734-OB8E</td><td>75 mA</td></tr> <tr><td>1734-OV2E</td><td>75 mA</td></tr> <tr><td>1734-OV4E</td><td>75 mA</td></tr> <tr><td>1734-OW2</td><td>80 mA</td></tr> <tr><td>1734-OX2</td><td>100 mA</td></tr> <tr><td>1734-IE2C</td><td>75 mA</td></tr> <tr><td>1734-OE2C</td><td>75 mA</td></tr> <tr><td>1734-IE2V</td><td>75 mA</td></tr> <tr><td>1734-OE2V</td><td>75 mA</td></tr> <tr><td>1734-IA2</td><td>75 mA</td></tr> <tr><td>1734-IM2</td><td>75 mA</td></tr> <tr><td>1734-OA2</td><td>75 mA</td></tr> <tr><td>1734-IJ2</td><td>160 mA</td></tr> <tr><td>1734-IK2</td><td>160 mA</td></tr> <tr><td>1734-IR2</td><td>220 mA</td></tr> <tr><td>1734-IT2I</td><td>175 mA</td></tr> <tr><td>1734-SSI</td><td>110 mA</td></tr> <tr><td>1734-VHSC5</td><td>180 mA</td></tr> <tr><td>1734-VHSC24</td><td>180 mA</td></tr> <tr><td>1734-232ASC</td><td>75 mA</td></tr> </tbody> </table>	Catalog Number	POINTBus Current Requirements	1734-IB2	75 mA	1734-IB4	75 mA	1734-IB8	75 mA	1734-IV2	75 mA	1734-IV4	75 mA	1734-OB2	75 mA	1734-OB4	75 mA	1734-OB8	75 mA	1734-OB2E	75 mA	1734-OB2EP	75 mA	1734-OB4E	75 mA	1734-OB8E	75 mA	1734-OV2E	75 mA	1734-OV4E	75 mA	1734-OW2	80 mA	1734-OX2	100 mA	1734-IE2C	75 mA	1734-OE2C	75 mA	1734-IE2V	75 mA	1734-OE2V	75 mA	1734-IA2	75 mA	1734-IM2	75 mA	1734-OA2	75 mA	1734-IJ2	160 mA	1734-IK2	160 mA	1734-IR2	220 mA	1734-IT2I	175 mA	1734-SSI	110 mA	1734-VHSC5	180 mA	1734-VHSC24	180 mA	1734-232ASC
Catalog Number	POINTBus Current Requirements																																																															
1734-IB2	75 mA																																																															
1734-IB4	75 mA																																																															
1734-IB8	75 mA																																																															
1734-IV2	75 mA																																																															
1734-IV4	75 mA																																																															
1734-OB2	75 mA																																																															
1734-OB4	75 mA																																																															
1734-OB8	75 mA																																																															
1734-OB2E	75 mA																																																															
1734-OB2EP	75 mA																																																															
1734-OB4E	75 mA																																																															
1734-OB8E	75 mA																																																															
1734-OV2E	75 mA																																																															
1734-OV4E	75 mA																																																															
1734-OW2	80 mA																																																															
1734-OX2	100 mA																																																															
1734-IE2C	75 mA																																																															
1734-OE2C	75 mA																																																															
1734-IE2V	75 mA																																																															
1734-OE2V	75 mA																																																															
1734-IA2	75 mA																																																															
1734-IM2	75 mA																																																															
1734-OA2	75 mA																																																															
1734-IJ2	160 mA																																																															
1734-IK2	160 mA																																																															
1734-IR2	220 mA																																																															
1734-IT2I	175 mA																																																															
1734-SSI	110 mA																																																															
1734-VHSC5	180 mA																																																															
1734-VHSC24	180 mA																																																															
1734-232ASC	75 mA																																																															

DeviceNet Power Supply Specifications

Attribute	Value
Input voltage rating, nom	24V DC
DeviceNet input voltage range	11...25V DC (DeviceNet specification)
Input overvoltage protection	Reverse polarity protected
DeviceNet power requirements	24V DC (+4% = 25V DC max) @ 30 mA max

Power Supply Specifications

Attribute	Value
Input voltage rating	24V DC nom, 10...28.8V DC range
Field side power requirements	24V DC (+20% = 28.8V DC max) @ 400 mA max
Inrush current, max	6 A for 10 ms
POINTBus output current, max	1 A @ 5V DC \pm 5% (4.75...5.25)
Input overvoltage protection	Reverse polarity protected
Interruption protection	Output voltage stays within specifications when input drops out for 10 ms at 10V with max load.
Power supply	For 1734-ADN, 1734-ADNK – User supplied power should be separate from DeviceNet power. For 1734-ADNX – User supplied power should be separate from DeviceNet and Subnet power.

General Specifications

Attribute	Value
Indicators	3 red/green status indicators: <ul style="list-style-type: none"> • Adapter status • DeviceNet status • POINTBus status 2 green power supply status indicators: <ul style="list-style-type: none"> • System Power (POINTBus 5V power) • Field Power (24V from field supply)
Mounting type	DIN rail
Weight, approx.	260 g (9.17 oz.)
Dimensions (H x W x D) approx.	79.8 x 56.3 x 133.1 mm (3.14 x 2.22 x 5.24 in.)
Module location	Starter module - Left side of POINT I/O system
Network name	DeviceNet
Termination type	None
Number of nodes, max	1
Electronic protection	No
Diagnostics	No
Enclosure required	Yes
Power consumption	8.1 W @ 28.8V DC
Power dissipation, max	2.8 W @ 28.8V
Communication interface type	Adapter
Device type	Communication interface
Thermal dissipation, max	9.5 BTU/hr @ 28.8V DC
Input byte capacity	248
Output byte capacity	248
Power supply 24V current load	400 mA
Field power bus voltage, nom	24V DC
Field power bus supply voltage range	10...28.8V DC
Field power bus supply current, max	10 A
Isolation voltage	50V continuous, test to withstand 800V DC for 60 s
Operating voltage range	10...28.8V DC
Wire size	2.5 mm ² (14 AWG) - 0.25 mm ² (22 AWG) solid or stranded, copper wire rated at 75 °C (167 °F) or greater 1.2 mm (3/64 in.) insulation max.
Wire category	1 on power ports 2 on communications ports
Wire type	Copper
Terminal base screw torque	0.5...0.6 N•m (5...7 lb•in)
Field wiring terminations, DeviceNet	1 - Black wire (V) 2 - Blue wire (CAN low) 3 - Bare wire (Shield) 4 - White wire (CAN high) 5 - Red wire (+V)
Field wiring terminations, power supply	0 - No connection 1 - No connection 2 - Chassis ground 3 - Chassis ground 4 - Common 5 - Common 6 - Supply 7 - Supply
Enclosure type rating	None (open-style)
North American temp code	T4A
UKEX/ATEX temp code	T4
IECEX temp code	T4

Environmental Specifications

Attribute	Value
Temperature, operating	IEC60068-2-1 (Test Ad, Operating Cold) IEC60068-2-2 (Test Bd, Operating Dry Heat) IEC60068-2-14 (Test Nb, Operating Thermal Shock) -20 °C ≤ Ta ≤ +55 °C (-4 °F ≤ Ta ≤ +131 °F)
Temperature, nonoperating	IEC60068-2-1 (Test Ab, Unpackaged Nonoperating Cold) IEC60068-2-2 (Test Bb, Unpackaged Nonoperating Dry Heat) IEC60068-2-14 (Test Na, Unpackaged Nonoperating Thermal Shock) -40...+85 °C (-40...+185 °F)

Environmental Specifications (Continued)

Attribute	Value
Temperature, surrounding air, max.	55 °C (131 °F)
Relative humidity	IEC60068-2-30 (Test Db, Unpackaged Nonoperating Damp Heat) 5...95% noncondensing
Vibration	IEC60068-2-6 (Test Fc, Operating) 5 g @ 10...500 Hz
Shock, operating	IEC 60068-2-27 (Test Ea, Unpackaged Shock) 30 g
Shock, nonoperating	IEC 60068-2-27 (Test Ea, Unpackaged Shock) 50 g
Emissions	IEC 61000-6-4
ESD immunity	IEC6100-4-2 6 kV contact discharges 8 kV air discharges
Radiated RF immunity	IEC 61000-4-3 10V/m with 1 kHz sine-wave 80% AM from 80...6000 MHz
EFT/B immunity	IEC 61000-4-4 +4 kV at 5 kHz on power ports +2 kV at 5 kHz on communications ports
Surge transient immunity	IEC 61000-4-5 +1 kV line-line (DM) and +2 kV line-earth (CM) on power ports +2 kV line-earth (CM) on communications ports
Conductive RF immunity	IEC61000-4-6 10V rms with 1 kHz sine-wave 80%AM from 150 kHz to 80 MHz

Certifications

Certification (when the product is marked) ⁽¹⁾	Value
c-UL-us	UL Listed Industrial Control Equipment, certified for US and Canada. See UL File E65584. UL Listed for Class I Division 2 Group A,B,C,D Hazardous Locations, certified for U.S. and Canada. See UL File E194810.
UK and CE	UK Statutory Instrument 2016 No. 1091 and European Union 2014/30/EU EMC Directive, compliant with: EN 61326-1; Meas./Control/Lab., Industrial Requirements EN 61000-6-2; Industrial Immunity EN 61000-6-4; Industrial Emissions EN 61131-2; Programmable Controllers (Clause 8, Zone A & B) UK Statutory Instrument 2012 No. 3032 and European Union 2011/65/EU RoHS, compliant with: EN IEC 63000; Technical documentation
Ex	UK Statutory Instrument 2016 No. 1107 and European Union 2014/34/EU ATEX Directive, compliant with: EN IEC 60079-0; General Requirements EN IEC 60079-7; Explosive Atmospheres, Protection "e" II 3 G Ex ec IIC T4 Gc DEMKO 04 ATEX 0330347X UL22UKEX2478X
IECEX	IECEX System, compliant with IEC 60079-0; General Requirements IEC 60079-7; Explosive Atmospheres, Protection "e" II 3 G Ex ec IIC T4 Gc IECEX UL 20.0072X
RCM	Australian Radiocommunications Act, compliant with: EN 61000-6-4; Industrial Emissions
KC	Korean Registration of Broadcasting and Communications Equipment, compliant with: Article 58-2 of Radio Waves Act, Clause 3
Morocco	Arrêté ministériel n° 6404-15 du 29 ramadan 1436
CCC	CNCA-C23-01 强制性产品认证实施规则 防爆电气 CNCA-C23-01 CCC Implementation Rule Explosion-Proof Electrical Products CCC: 202012230911607

(1) See the Product Certification link at rok.auto/certifications for Declarations of Conformity, Certificates, and other certification details.

Additional Resources

For more information on the products that are described in this publication, use these resources. You can view or download publications at rok.auto/literature.

Resource	Description
POINT I/O Modules Selection Guide, publication 1734-SG001	Provides information on how to select POINT I/O adapters, terminal bases, I/O modules, and accessories.
POINT I/O DeviceNet Adapter User Manual, publication 1734-UM002	A detailed description of module functionality, configuration, installation procedure, and information on how to use the POINT I/O DeviceNet adapters.
Industrial Automation Wiring and Grounding Guidelines, publication 1770-4.1	More information on proper wiring and grounding techniques.
Product Certifications website, rok.auto/certifications	Provides declarations of conformity, certificates, and other certification details.

Rockwell Automation Support

Use these resources to access support information.

Technical Support Center	Find help with how-to videos, FAQs, chat, user forums, Knowledgebase, and product notification updates.	rok.auto/support
Local Technical Support Phone Numbers	Locate the telephone number for your country.	rok.auto/phonesupport
Technical Documentation Center	Quickly access and download technical specifications, installation instructions, and user manuals.	rok.auto/techdocs
Literature Library	Find installation instructions, manuals, brochures, and technical data publications.	rok.auto/literature
Product Compatibility and Download Center (PCDC)	Download firmware, associated files (such as AOP, EDS, and DTM), and access product release notes.	rok.auto/pcdc

Documentation Feedback

Your comments help us serve your documentation needs better. If you have any suggestions on how to improve our content, complete the form at rok.auto/docfeedback.





Waste Electrical and Electronic Equipment (WEEE)



At the end of life, this equipment should be collected separately from any unsorted municipal waste.

Rockwell Automation maintains current product environmental compliance information on its website at rok.auto/pec.

Rockwell Otomasyon Ticaret A.Ş. Kar Plaza İş Merkezi E Blok Kat:6 34752 İçerenköy, İstanbul, Tel: +90 (216) 5698400 EEE Yönetmeliğine Uygundur

Connect with us.    

rockwellautomation.com — expanding **human possibility**[®]

AMERICAS: Rockwell Automation, 1201 South Second Street, Milwaukee, WI 53204-2496 USA, Tel: (1) 414.382.2000

EUROPE/MIDDLE EAST/AFRICA: Rockwell Automation NV, Pegasus Park, De Kleetlaan 12a, 1831 Diegem, Belgium, Tel: (32) 2663 0600

ASIA PACIFIC: Rockwell Automation SEA Pte Ltd, 2 Corporation Road, #04-05, Main Lobby, Corporation Place, Singapore 618494, Tel: (65) 6510 6608

UNITED KINGDOM: Rockwell Automation Ltd., Pitfield, Kiln Farm, Milton Keynes, MK11 3DR, United Kingdom, Tel: (44)(1908) 838-800

Allen-Bradley, expanding human possibility, FactoryTalk, POINT I/O, POINTBus, Rockwell Automation, RSNetWorx for DeviceNet, and TechConnect are trademarks of Rockwell Automation, Inc.

DeviceNet is a trademark of ODVA, Inc.

Trademarks not belonging to Rockwell Automation are property of their respective companies.

Publication 1734-IN026F-EN-P - January 2026 | Supersedes Publication 1734-IN026E-EN-P - February 2024

Copyright © 2026 Rockwell Automation, Inc. All rights reserved. Printed in Singapore.

PN-741104